

男子ダブルス

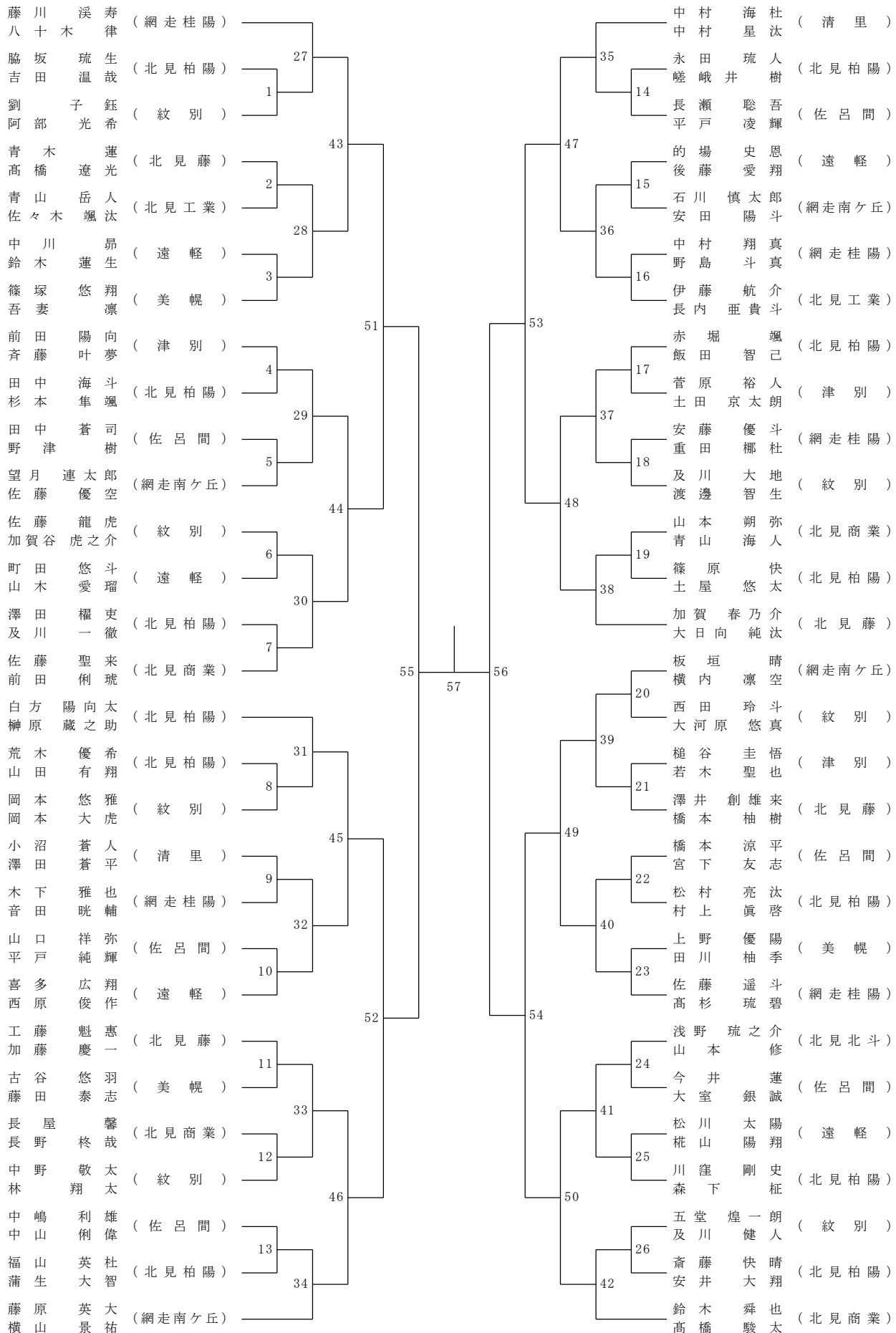

三位決定戦

58

男子シングルス

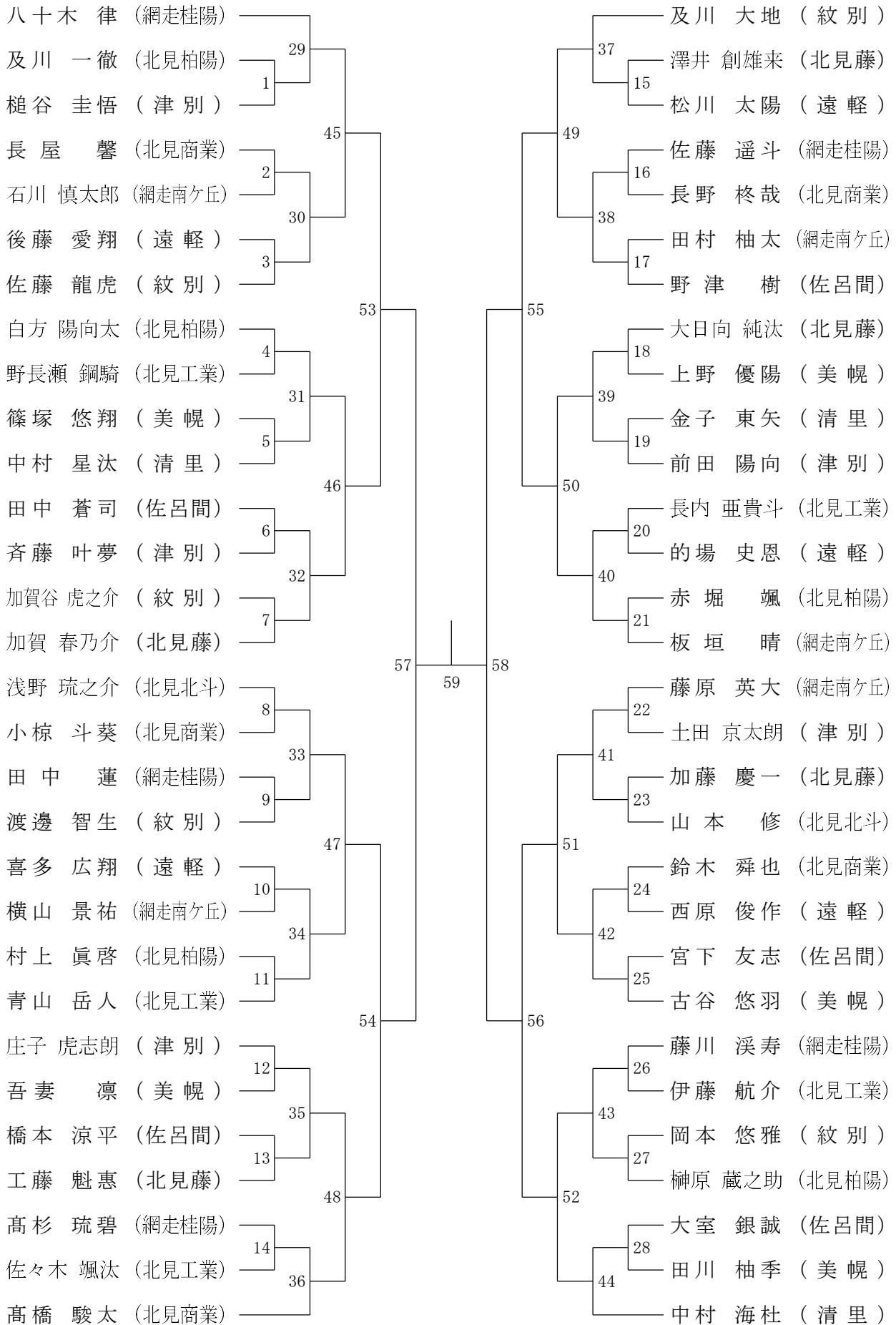

三位決定戦



女子ダブルス



三位決定戦



女子シングルス

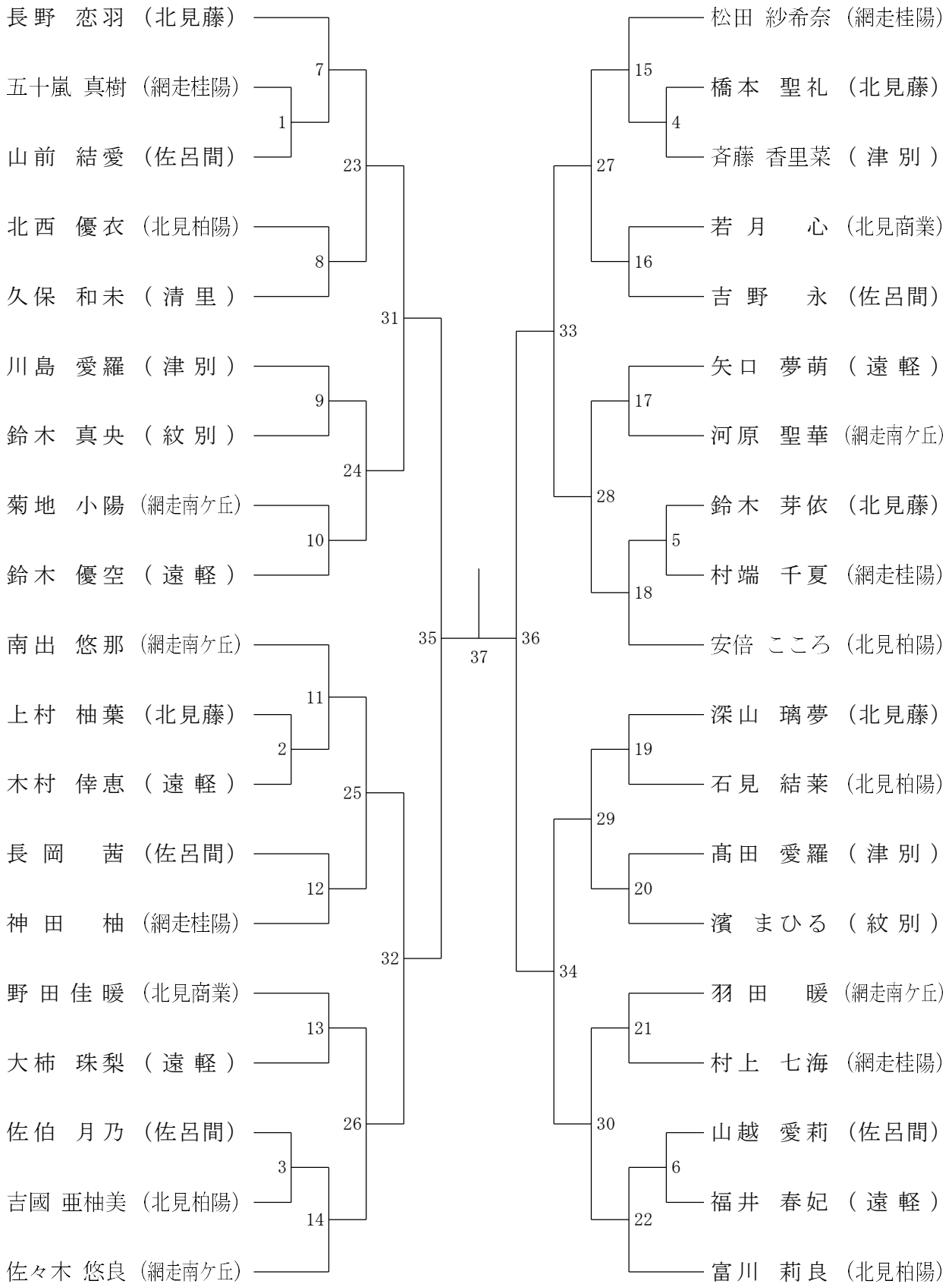

三位決定戦



男子ダブルス順位決め

BD : 5 1 L

BD : 5 2 L

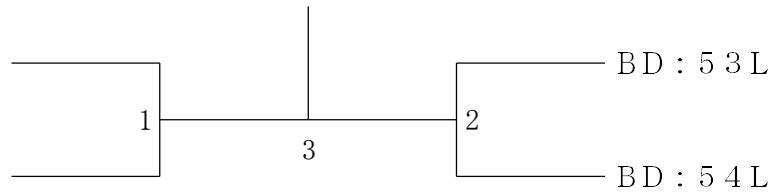

三位決定戦



女子ダブルス順位決め

GD : 2 0 L

GD : 2 1 L

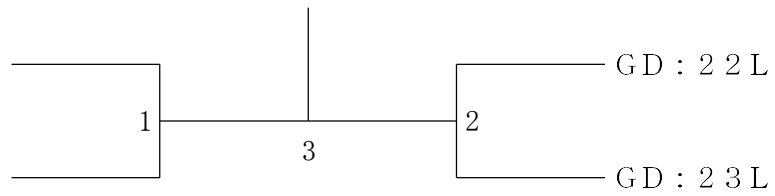

三位決定戦



男子シングルス順位決め

BS : 5 3 L

BS : 5 4 L

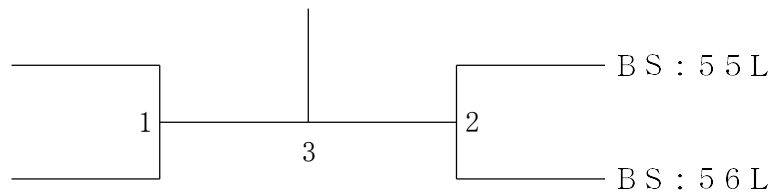

三位決定戦

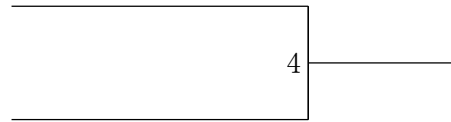

女子シングルス順位決め

GS : 3 1 L

GS : 3 2 L

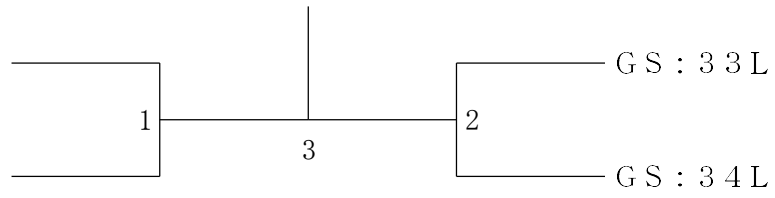

三位決定戦

